

Technical data sheet

Locknut, PG thread

Item number: 2091097



Locknuts, part M to DIN 46320 with Pg thread to DIN 40430. * Price according to DEL notation.



CuZn
37 Brass

N Nickel-plated

Master data

Item number	2091097
Type	169 MS PG 9
Description 1	Locknut
Manufacturer	OBO
Dimension	PG9
Material	Brass
Surface	Nickel-plated
Surface standard	
Smallest sales unit	100
Unit of quantity	Units
Weight	0,26 kg
Weight unit	kg/100 pairs

Technical data sheet

Locknut, PG thread

Item number: 2091097



Dimensions

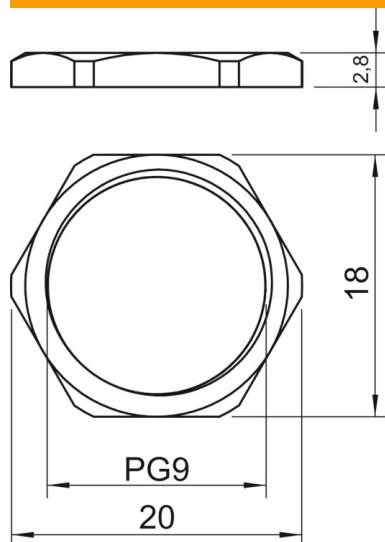

Dimension E	20 mm
Dimension L	2,8 mm

Technical specifications

Thread	Pg_9
Thread type	Pg
Nominal thread size metric/PG	9
Fibre-glass reinforced	no
Halogen-free	no
Impact-resistant	no
WAF	18